



**ABSCO
SHEDS**
So Tough. Too Easy.

**SHEDS &
OUTDOOR
STRUCTURES**

www.abscosheds.com.au

SHEDS

GARAGES

CARPORTS

PATIO COVERS

CHICKEN COOPS

ACCESSORIES



SNAP TITE
World's Easiest Assembly System
UNIQUE PATENTED SYSTEM



**ABSCO SHEDS
ASSEMBLY APP**

AVAILABLE ON +



Call 1800 029 701 for 7 Day Customer Service

CONTENTS

03 SPACE SAVER STORAGE

05 PREMIER GARDEN SHED

07 REGENT GARDEN SHED

09 BASIC SHED / POOL PUMP COVER / BIKE SHEDS

10 EZI STORAGE

11 HIGHLANDER SHED

12 UTILITY SHED

13 WORKSHOP SHED

14 FORTRESS SHED

15 RURAL SHED

16 BUSHRANGER SHED

17 CHICKEN COOPS

19 GARAGES

21 PATIO COVER

22 SKILLION ROOF CARPORTS

24 GABLE ROOF CARPORTS

26 ECONOMY SPACE SAVER STORAGE

27 ECONOMY PREMIER SHEDS / ECONOMY WORKSHOP SHEDS

28 ACCESSORIES

29 CYCLONE KIT

30 MATRIX TABLE

SPACE SAVER STORAGE



MAINTENANCE
FREE



PRE-DRILLED
HOLES



SNAPTITE
ASSEMBLY



30082SK Shown in Classic Cream™

The ultimate storage for those areas where space is limited. Fits under eaves and is large enough to store tools, sporting equipment and more. Ideal for storage in garages and carports in unit complexes.

PRODUCT

SPECIFICATIONS

DIMENSIONS



MODEL 15081SK

- » 1.52mW x 0.78mD x 1.95mH
- » Shown in Zincalume®
- » Skillion Roof, Single Door
- » Wind rated N2

Zincalume® \$286

Colour® \$388

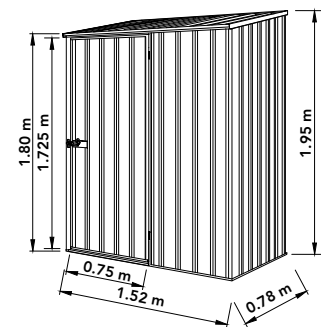

MODEL 15151SK

- » 1.52mW x 1.52mD x 2.08mH
- » Shown in Pale Eucalypt®
- » Skillion Roof, Single Door
- » Wind rated N2

Zincalume® \$492

Colour® \$560

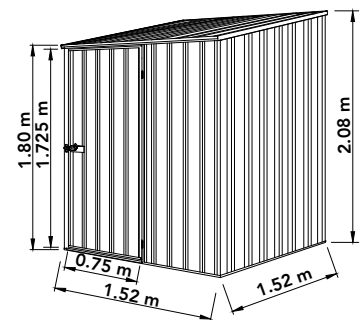

MODEL 23081SK

- » 2.26mW x 0.78mD x 1.95mH
- » Shown in Woodland Grey®
- » Skillion Roof, Single Door

Zincalume® \$560

Colour® \$629

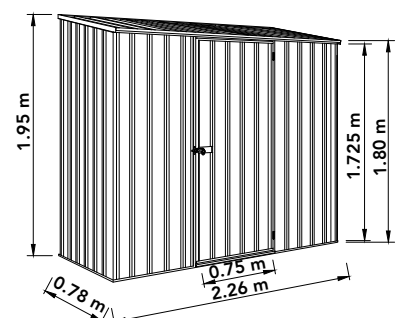



MODEL 23151SK

- » 2.26mW x 1.52mD x 2.08mH
- » Shown in Classic Cream™
- » Skillion Roof, Single Door
- » Wind rated N2

Zincalume® \$663

Colour® \$731

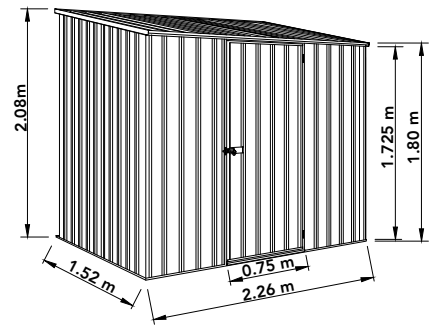

MODEL 30082SK

- » 3.00mW x 0.78mD x 1.95mH
- » Shown in Pale Eucalypt®
- » Skillion Roof
- » Hinged Double Doors

Zincalume® \$693

Colour® \$858

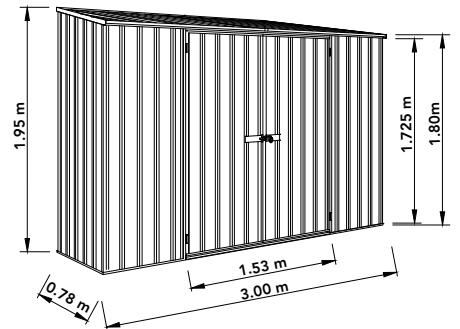

MODEL 30151SK

- » 3.00mW x 1.52mD x 2.08mH
- » Shown in Monument®
- » Skillion Roof, Single Door
- » Wind rated N2

Zincalume® \$812

Colour® \$868

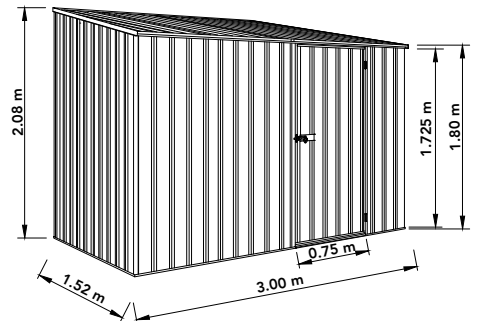

MODEL 30152SK

- » 3.00mW x 1.52mD x 2.08mH
- » Shown in Woodland Grey®
- » Skillion Roof, Double Door
- » Wind rated N2

Zincalume® \$544

Colour® \$566

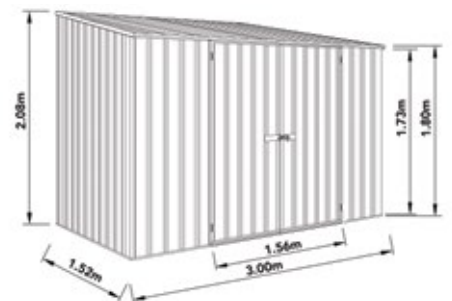

SPACE SAVER COLOUR OPTIONS:

Zincalume® (ZA)	Classic Cream™ (CC)	Pale Eucalypt® (PE)	Woodland Grey® (WG)	Monument® (MN)
--------------------	------------------------	------------------------	------------------------	-------------------



See specifications for wind ratings. CYCSKRSK Cyclone kit available for these models. Excludes models 15081SK, 23081SK, and 30082SK.

PREMIER GARDEN SHED



MAINTENANCE
FREE



PRE-DRILLED
HOLES



SNAPTITE
ASSEMBLY



Designed for maximum strength and manufactured from low maintenance ribbed steel sheeting for added security. Comes with gable roof and one or two door configurations. For number of doors and dimensions see model diagrams below.

30302GK Shown in Classic Cream™

PRODUCT

SPECIFICATIONS

DIMENSIONS



MODEL 15151GK

- » 1.52mW x 1.52mD x 1.95mH
- » Shown in Zinalume®
- » Gable Roof, Single Door
- » Wind Rated N2

Zinalume® \$583 Colour® \$663

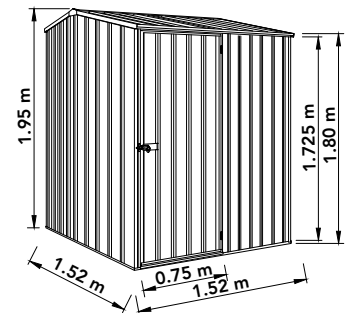

MODEL 23151GK

- » 2.26mW x 1.52mD x 1.95mH
- » Shown in Classic Cream™
- » Gable Roof, Single Door
- » Wind Rated N2

Zinalume® \$629 Colour® \$823

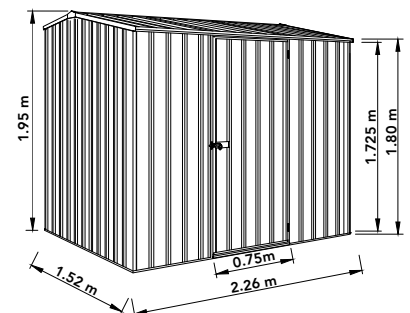



MODEL 23231GK

- » 2.26mW x 2.26mD x 2.00mH
- » Shown in Monument®
- » Gable Roof, Single Door
- » Wind Rated N2

Zincalume® \$685

Colour® \$858

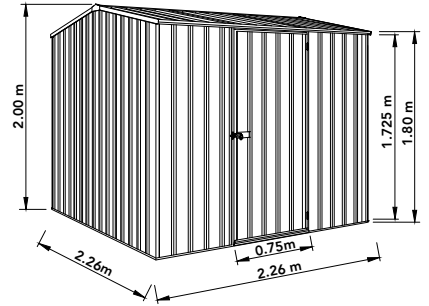

MODEL 30152GK

- » 3.00mW x 1.52mD x 1.95mH
- » Shown in Pale Eucalypt®
- » Gable Roof, Double Door
- » Wind Rated N2

Zincalume® \$606

Colour® \$739

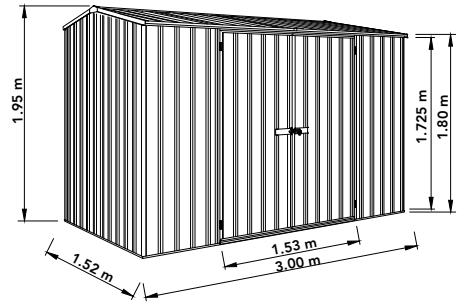

MODEL 30232GK

- » 3.00mW x 2.26mD x 2.00mH
- » Shown in Classic Cream™
- » Gable Roof, Double Door
- » Wind Rated N2

Zincalume® \$571

Colour® \$675

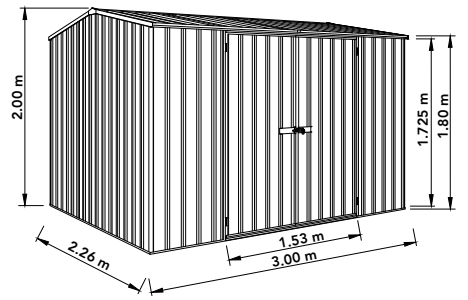

MODEL 30302GK

- » 3.00mW x 3.00mD x 2.06mH
- » Shown in Woodland Grey®
- » Gable Roof, Double Door
- » Wind Rated N2

Zincalume® \$812

Colour® \$868

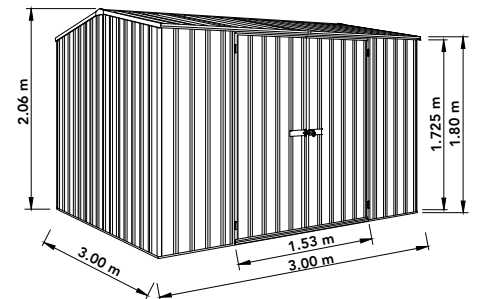

PREMIER COLOUR OPTIONS:

Zincalume® (ZA)	Classic Cream™ (CC)	Pale Eucalypt® (PE)	Woodland Grey® (WG)	Monument® (MN)
--------------------	------------------------	------------------------	------------------------	-------------------



Premier models are wind rated N2. CYCGK Cyclone kits available for these models. CYC15 available for 15151GK.

REGENT GARDEN SHED



MAINTENANCE
FREE



PRE-DRILLED
HOLES



SNAPTITE
ASSEMBLY



30142RK Shown in Woodland Grey®

Manufactured from low maintenance ribbed steel sheeting. Doors open at the gable end and the roof has a slight overhang to add to the overall appearance. Doors are hinged and braced for strength and rigidity.

PRODUCT

SPECIFICATIONS

DIMENSIONS



MODEL 23141RK

- » 2.26mW x 1.44mD x 2.00mH
- » Shown in Pale Eucalypt®
- » Gable Roof, Single Door
- » Wind Rated N2

Colour® \$800

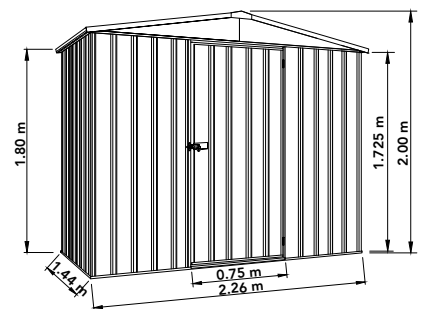

MODEL 23221RK

- » 2.26mW x 2.18mD x 2.00mH
- » Shown in Woodland Grey®
- » Gable Roof, Single Door
- » Wind Rated N2

Colour® \$880

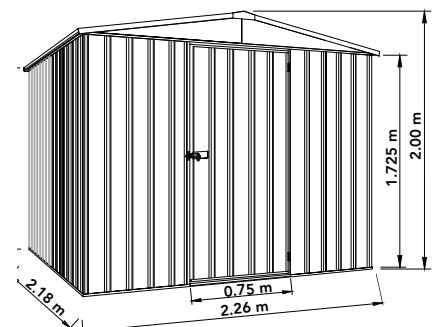



MODEL 30142RK

- » 3.00mW x 1.44mD x 2.06mH
- » Shown in Woodland Grey®
- » Gable Roof, Double Door
- » Wind Rated N2

Colour® \$1,234

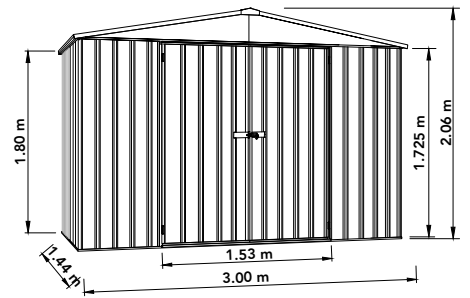

MODEL 30222RK

- » 3.00mW x 2.18mD x 2.06mH
- » Shown in Classic Cream™
- » Gable Roof, Double Door
- » Wind Rated N2

Colour® \$1,349

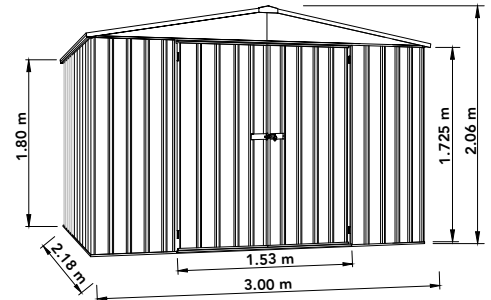

MODEL 30292RK

- » 3.00mW x 2.92mD x 2.06mH
- » Shown in Pale Eucalypt®
- » Gable Roof, Double Door
- » Wind Rated N2

Colour® \$1,454

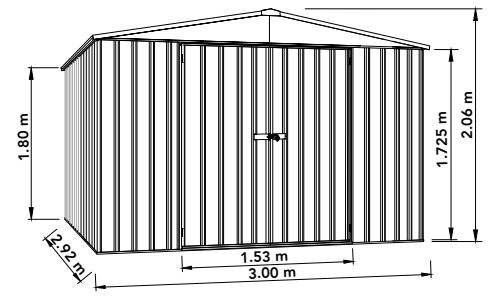

MODEL 30372RK

- » 3.00mW x 3.66mD x 2.06mH
- » Shown in Woodland Grey®
- » Gable Roof, Double Door
- » Wind Rated N2

Colour® \$1,521

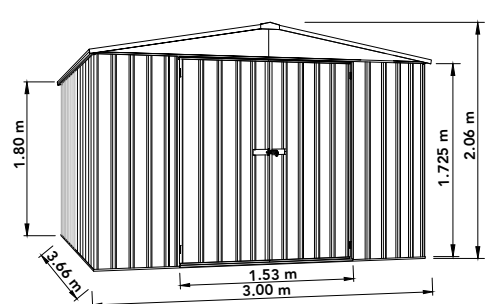

REGENT COLOUR OPTIONS:

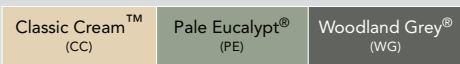

Regent models are wind rated N2. CYCRK Cyclone kits available for these models. CYC15 available for 15141RK.

BASIC SHED / POOL PUMP COVER / BIKE SHED

PRODUCT

SPECIFICATIONS

DIMENSIONS



BASIC SHED 15231FK

- » 1.52mW x 2.26mD x 1.80mH
- » Shown in Zinalume®
- » Not available in Pale Eucalypt®
- » Flat Roof, Single Door
- » Wind Rated N2

Zinalume® \$511

Colour® \$693

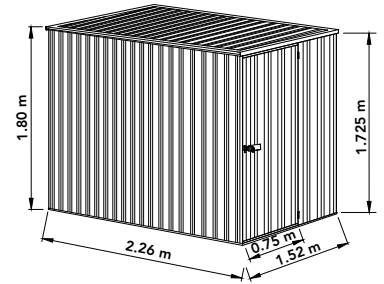

BASIC SHED 15301FK

- » 1.52mW x 3.00mD x 1.80mH
- » Shown in Monument®
- » Not available in Pale Eucalypt®
- » Flat Roof, Single Door
- » Wind Rated N2

Zinalume® \$577

Colour® \$835

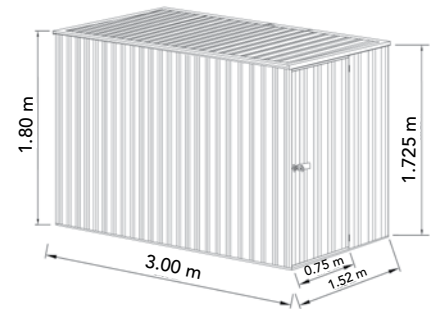

POOL PUMP COVER PPCK

- » 1.52mW x 1.52mD x 1.49mH
- » Shown in Woodland Grey®
- » Available in all colours
- » Hinged Skillion Roof
- » Front access door

Zinalume® \$510

Colour® \$570

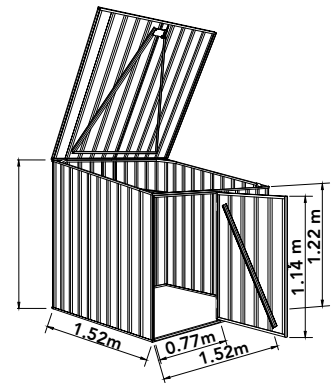

BIKE SHED 230813BK

- » 2.26mW x 0.78mD x 1.31mH
- » Shown in Woodland Grey®
- » Not available in Zinalume®
- » Hatch Skillion Roof, Double Doors
- » Stores up to 3 adult bikes

Colour® \$342

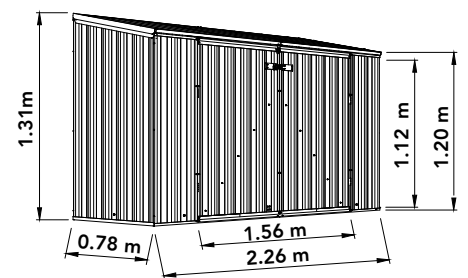

BIKE SHED J30153BK

- » 3.00mW x 1.52mD x 2.08mH
- » Shown in Woodland Grey®
- » Only available in Pale Eucalypt® and Woodland Grey® and Classic Cream™
- » Skillion Roof, Three Doors
- » Wind Rated N2

Colour® \$598

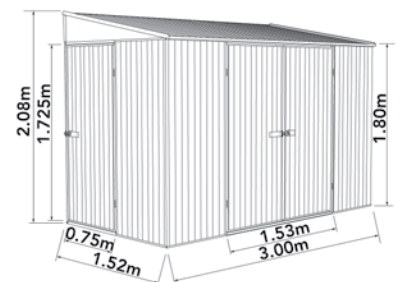

COLOUR OPTIONS:

Zinalume® (ZA)	Classic Cream™ (CC)	Pale Eucalypt® (PE)	Woodland Grey® (WG)	Monument® (MN)
-------------------	------------------------	------------------------	------------------------	-------------------



MAINTENANCE
FREE



PRE-DRILLED
HOLES



SNAPTITE
ASSEMBLY

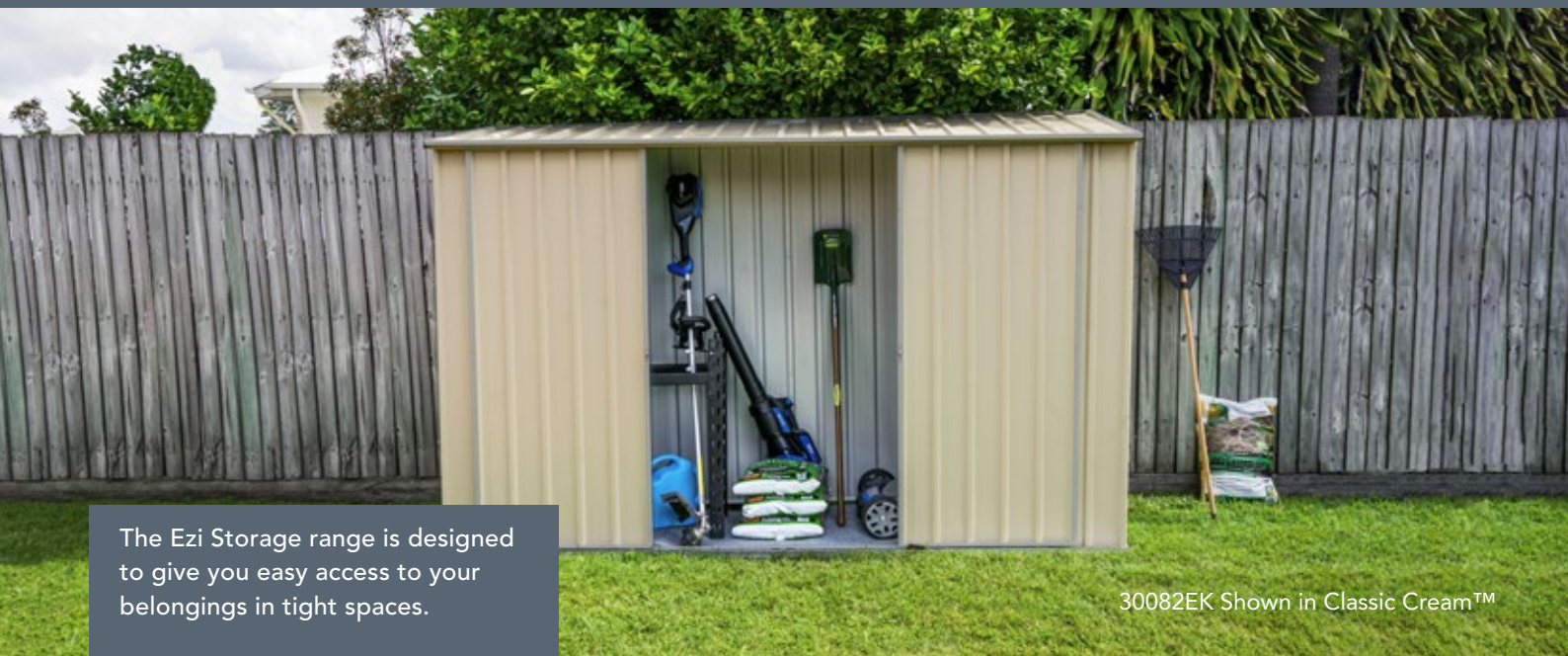

The Ezi Storage range is designed to give you easy access to your belongings in tight spaces.

30082EK Shown in Classic Cream™

PRODUCT

SPECIFICATIONS

DIMENSIONS



EZI STORAGE 08081FK

- » 0.78mW x 0.78mD x 1.80mH
- » Shown in Classic Cream™
- » Flat Roof, Single Door

Zincalume® \$289

Colour® \$326

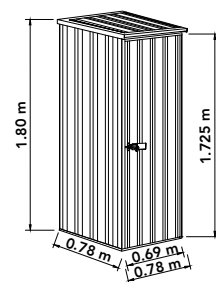

EZI STORAGE 08151FK

- » 0.78mW x 1.52mD x 1.80mH
- » Shown in Monument®
- » Flat Roof, Single Door

Zincalume® \$326

Colour® \$402

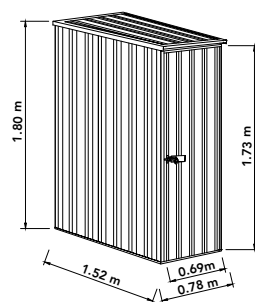

EZI STORAGE 30082EK*

- » 3.00mW x 0.78mD x 1.95mH
- » Shown in Zincalume®
- » Skillion Roof, Double Sliding Doors
- » Wind Rated N2

Zincalume® \$548

Colour® \$548

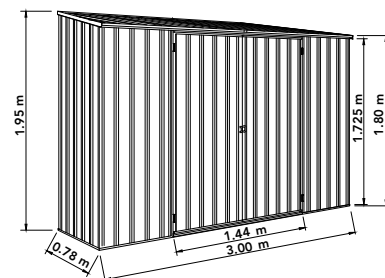

*Wall footprint is 0.78m. The doors/door track sits in front of the walls, making the total depth 0.852m

COLOUR OPTIONS:

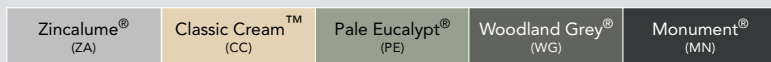

*30082EK only available in Zincalume®, Classic Cream™ and Woodland Grey®

HIGHLANDER SHED



ABSCO SHEDS
ASSEMBLY APP

AVAILABLE ON +

PRODUCT

SPECIFICATIONS

DIMENSIONS



MODEL 30292HK

- » 3.00mW x 2.92mD x 2.30mH
- » Shown in Zinalume®
- » Gable Roof, Double Doors

Zinalume® \$1,315

Colour® \$1,681

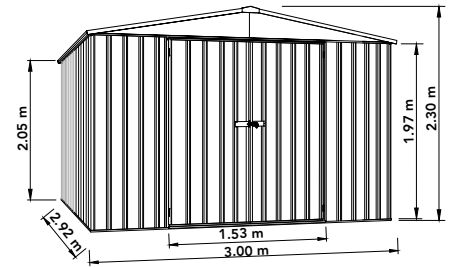

MODEL 45232HK

- » 4.48mW x 2.26mD x 2.30mH
- » Shown in Classic Cream™
- » Gable Roof, Double Doors

Zinalume® \$2,126

Colour® \$2,618

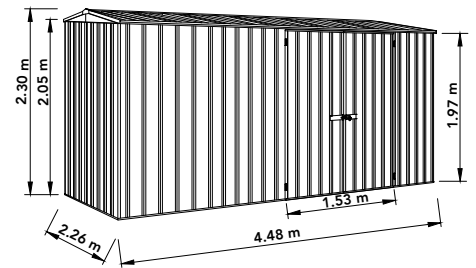

MODEL 60303HK

- » 5.96mW x 3.00mD x 2.30mH
- » Shown in Classic Cream™
- » Gable Roof, Double Doors
- » Single personal access door

Zinalume® \$2,812

Colour® \$3,487

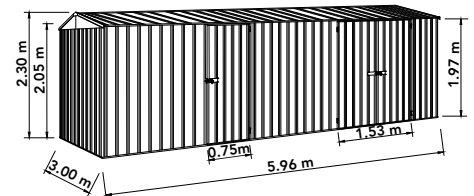

MODEL 3045HK

- » 3.00mW x 4.48mD x 2.30mH
- » Shown in Pale Eucalypt®
- » Gable Roof, Double Doors
- » Single personal access door

Zinalume® \$2,458

Colour® \$3,082

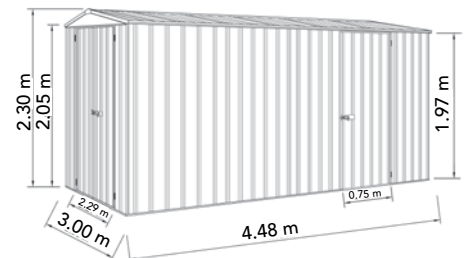

MODEL 3060HK

- » 3.00mW x 5.96mD x 2.30mH
- » Shown in Woodland Grey®
- » Gable Roof, Double Doors
- » Single personal access door

Zinalume® \$3,122

Colour® \$3,773

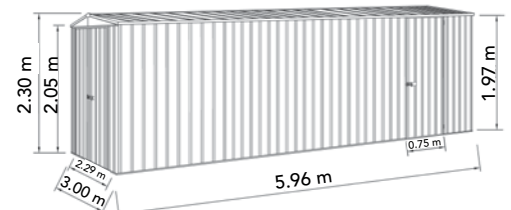

HIGHLANDER COLOUR OPTIONS:

Zinalume®
(ZA)

Classic Cream™
(CC)

Pale Eucalypt®
(PE)

Woodland Grey®
(WG)

EXTRA HIGH GARDEN SHED

2300mm high at the gable, this shed is ideal for the taller guy and the serious handyman.



Highlander Sheds are wind rated N2. CYCHK Cyclone kit available for these models.

UTILITY SHED



MAINTENANCE
FREE



PRE-DRILLED
HOLES



SNAPTITE
ASSEMBLY



3060UTK Shown in Woodland Grey®

Designed for your trailer, boat or car. Featuring an extra large door opening at the gable end, with a personal access side door, braced for added strength and security.

PRODUCT

SPECIFICATIONS

DIMENSIONS



MODEL 3045UTK

- » 3.00mW x 4.48mD x 2.06mH
- » Shown in Zinalume®
- » Gable Roof, Double Door
- » Personal access door included

Zinalume® \$2,177

Colour® \$2,458

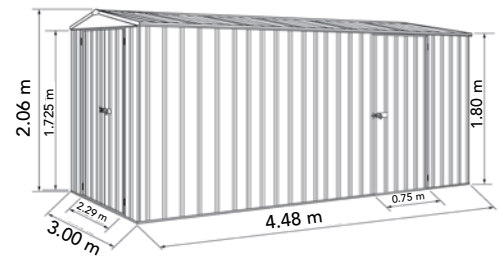

MODEL 3060UTK

- » 3.00mW x 5.96mD x 2.06mH
- » Shown in Pale Eucalypt®
- » Gable Roof, Double Door
- » Personal access door included

Zinalume® \$2,618

Colour® \$3,155

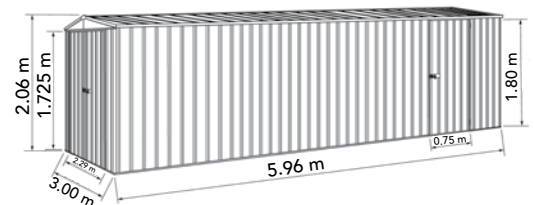

UTILITY COLOUR OPTIONS:

Zinalume®
(ZA)

Classic Cream™
(CC)

Pale Eucalypt®
(PE)

Woodland Grey®
(WG)



Utility Sheds are wind rated N2.
CYCWKUTK Cyclone kit available
for Workshop and Utility models.

WORKSHOP SHED



MAINTENANCE
FREE



PRE-DRILLED
HOLES



SNAPTITE
ASSEMBLY



60303WK Shown in Zinalume®

Suitable as a workshop for the hobbyist or a large storage area for the serious gardener.

PRODUCT

SPECIFICATIONS

DIMENSIONS



MODEL 45232WK

- » 4.48mW x 2.26mD x 2.00mH
- » Shown in Zinalume®
- » Gable Roof, Double Door

Zinalume® \$995

Colour® \$1,246

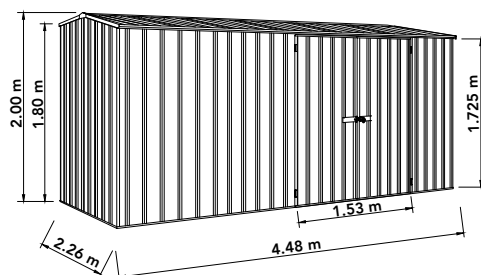

MODEL 45302WK

- » 4.48mW x 3.00mD x 2.06mH
- » Shown in Woodland Grey®
- » Gable Roof, Double Door

Zinalume® \$1,932

Colour® \$2,332

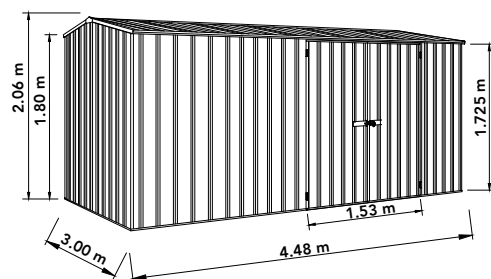

MODEL 60303WK

- » 5.96mW x 3.00mD x 2.06mH
- » Shown in Classic Cream™
- » Gable Roof, Double Door
- » Single personal access door

Zinalume® \$1,252

Colour® \$2,341

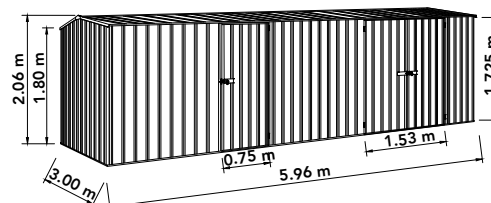

WORKSHOP COLOUR OPTIONS:

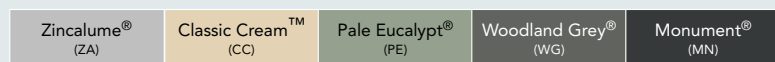

Workshop Sheds are wind rated N2. CYCWKUTK Cyclone kit available for Workshop and Utility models.

FORTRESS SHED

AVAILABLE IN:

Classic Cream™
(CC)

Woodland Grey®
(WG)

Monument®
(MN)

Taking security to the next level.

Heavy duty framework makes the Fortress highly resistant to break-ins.



Model 30151LK Shown in Monument®

PRODUCT

SPECIFICATIONS

DIMENSIONS



MODEL: 30081LK

- » 3.00mW x 0.78mD x 2.40mH
- » Shown in Monument®
- » Roller Door, Flat Roof
- » Downpipes and gutters included
- » Strong internal bracing

Colour® \$2,559

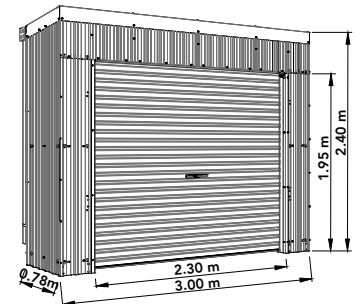

*Wall footprint is 0.78m. The gutter/downpipe sits behind the shed making the total depth 0.90m



MODEL: 30151LK

- » 3.00mW x 1.52mD x 2.40mH
- » Shown in Classic Cream™
- » Roller Door, Flat Roof
- » Downpipes and gutters included
- » Strong internal bracing

Colour® \$3,778

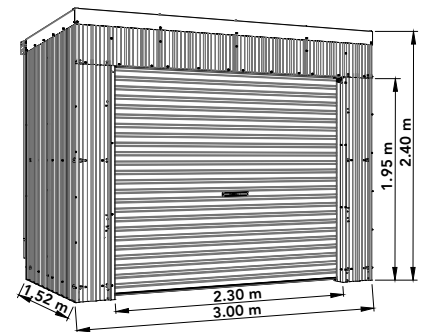

MODEL: 30301LK

- » 3.00mW x 3.00mD x 2.40mH
- » Shown in Woodland Grey®
- » Roller Door, Flat Roof
- » Downpipes and gutters included
- » Strong internal bracing

Colour® \$4,355

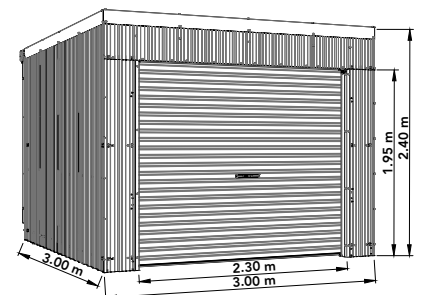

RURAL SHED



LIFETIME WARRANTY



AUSTRALIAN MADE



MAINTENANCE FREE



The Rural Shed is designed to have a wide clearance, gable roof and durable bracing to be fit for purpose on any farm or industrial site.

3030RS Shown in Pale Eucalypt®

PRODUCT

SPECIFICATIONS

DIMENSIONS



MODEL: 3030RS

- » 3.00mW x 3.00mD x 2.53mH
- » Shown in Woodland Grey®
- » Gutters and Downpipes included
- » Strong Internal Framework
- » Wind Rating N2

Zincalume® \$1,829

Colour® \$2,401

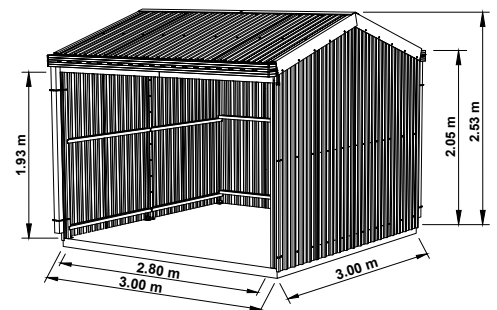

RURAL SHED COLOUR OPTIONS:

Zincalume® (ZA)	Pale Eucalypt® (PE)	Woodland Grey® (WG)	Monument® (MN)
--------------------	------------------------	------------------------	-------------------

NOTE: Engineers plans for submission to local authority required. Check with your local council before ordering.

BUSHRANGER SHED



SNAPTITE
ASSEMBLY



AUSTRALIAN
MADE



MAINTENANCE
FREE



3023BRK Shown in Woodland Grey®

The perfect combination of both a garden shed and garage, designed to have extra strong internal bracing, the Bushranger Shed is stronger than just your average garden shed.

PRODUCT

SPECIFICATIONS

DIMENSIONS



BUSHRANGER 3023BRK

- » 3.00mW x 2.26mD x 2.30mH
- » Shown in Classic Cream™
- » Matching Roller Shutter Door
- » Gable roof

Colour® \$ 2,492

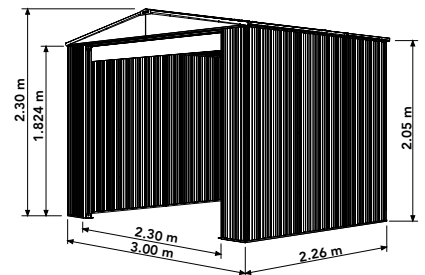

BUSHRANGER 3030BRK

- » 3.00mW x 3.00mD x 2.30mH
- » Shown in Pale Eucalypt® with Surf Mist® door
- » Gable roof
- » Door in Surf Mist®

Colour® \$2,744

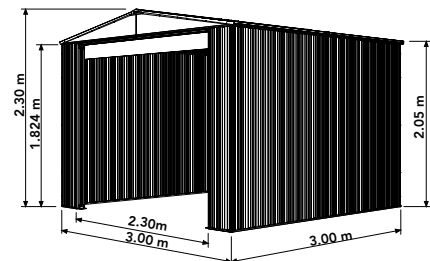

HIGHLANDER GARAGE 3060HGK

- » 3.00mW x 5.96mD x 2.30mH
- » Shown in Woodland Grey®
- » Matching Door
- » Single side access door included

Colour® \$4,170

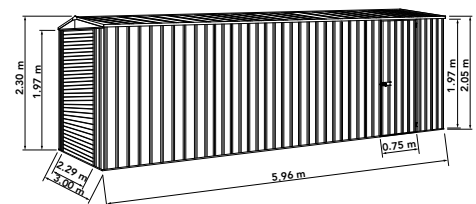

COLOUR OPTIONS:

Classic Cream™
(CC)

Pale Eucalypt®
(PE)

Woodland Grey®
(WG)

NOTE: All models come with a SurfMist® gable piece. Pale Eucalypt Bushrangers have a SurfMist® Door, all other models have a matching door. All Bushrangers come with a Rollashield Premium Roller Shutter Door, with an optional electric motor (sold separately at time of purchase). The warranty of both the Rollashield Premium Roller Shutter Door and electric motor are not covered under Absco's Lifetime Warranty.

CHICKEN COOPS



MAINTENANCE
FREE



PRE-DRILLED
HOLES



SNAPTITE
ASSEMBLY



A15081FKFD Shown in Pale Eucalypt®

Features:

- All steel construction facilitates cleaning and is more hygienic
- Wider mesh panels for better viewing
- Standard mesh is 12.5mm sq x 1.2mm thick

PRODUCT

SPECIFICATIONS

DIMENSIONS



MODEL: A15081FKFD

- » 1.52mW x 0.78mD x 1.80mH
- » Shown in Pale Eucalypt®
- » Wide mesh panels for easy viewing
- » Flat Roof, Single Door

Zincalume® \$320

Colour® \$492



MODEL: A15151FKFD

- » 1.52mW x 1.52mD x 1.80mH
- » Shown in Zincalume®
- » Wide mesh panels for easy viewing
- » Flat Roof, Single Door

Zincalume® \$457

Colour® \$633

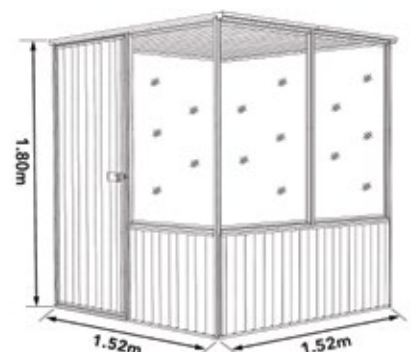



MODEL: A15301FKFD

- » 1.52mW x 2.96mD x 1.80mH
- » Shown in Pale Eucalypt®
- » Wide mesh panels for easy viewing
- » Flat Roof, Single Door

Zincalume® \$731

Colour® \$880

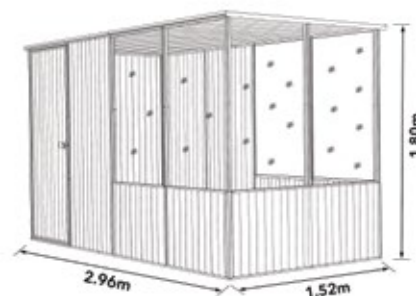

MODEL: A23151GKFD

- » 2.26mW x 1.52mD x 2.00mH
- » Shown in Zincalume®
- » Wide mesh panels for easy viewing
- » Gable Roof, Single Door

Zincalume® \$697

Colour® \$823

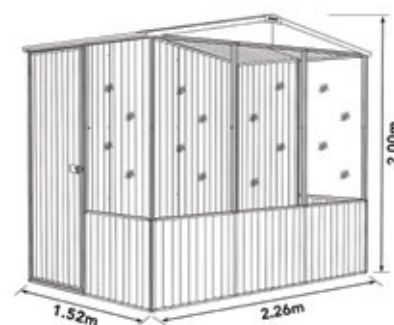

MODEL: A23231GKFD

- » 2.26mW x 2.22mD x 2.00mH
- » Shown in Pale Eucalypt®
- » Wide mesh panels for easy viewing
- » Gable Roof, Single Door

Zincalume® \$903

Colour® \$1,029

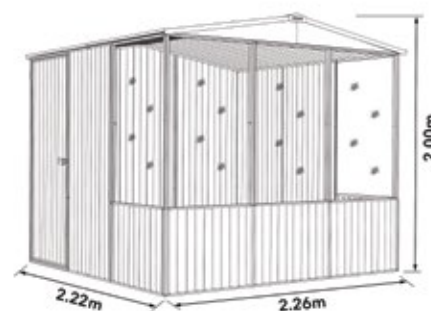

MODEL: A30231GKFD

- » 3.00mW x 2.22mD x 2.06mH
- » Shown in Zincalume®
- » Wide mesh panels for easy viewing
- » Gable Roof, Single Door

Zincalume® \$1,109

Colour® \$1,246

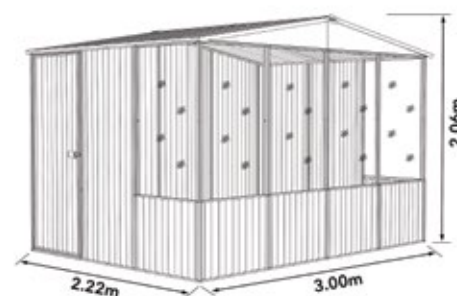

**HUNGRY CHOOKS
FEEDER & DRINKER - \$79**

- » 2.4L Chicken Feeder & 2.4L Drinker
- » All screws and bolts required to mount your feeder & drinker

Easy, clean, low-maintenance, all-in-one chicken feeder and drinker system. Hungry Chooks is mounted off the ground reducing the presence of rodents and pests. The PVC fittings and bolt-on storm cover guarantees your feed will remain dry.

CHICKEN COOP COLOUR OPTIONS:

Zincalume®
(ZA)

Pale Eucalypt®
(PE)





Absco Garages are a robust storage solution with strong internal framework. They come in single and double sizes, with the option for hinged barn doors or roller doors.

Double Barn Door CG56552N2 in Woodland Grey®

PRODUCT

SPECIFICATIONS

DIMENSIONS



MODEL: CG34552N2

- » 3.42mW x 5.50mD x 2.47mH
- » Shown in Classic Cream™
- » Single Garage with double hinged barn doors
- » Personal access door available
- » Wind Rating: N2

Colour® \$3,865

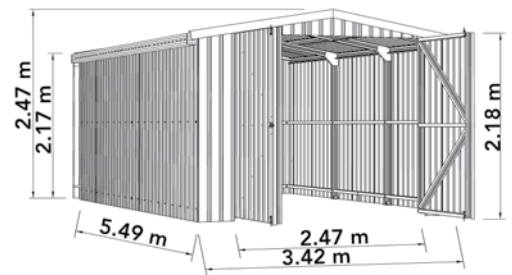

MODEL: CG56552N2

- » 5.64mW x 5.50mD x 2.64mH
- » Shown in Monument®
- » Double Garage with double hinged barn doors
- » Personal access door available
- » Wind Rating: N2

Colour® \$4,410

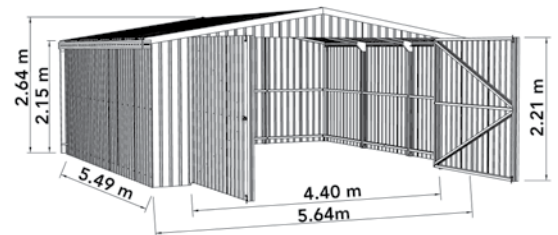

GARAGE COLOUR OPTIONS

Classic Cream™ (CC)	Pale Eucalypt® (PE)	Woodland Grey® (WG)	Monument® (MN)
------------------------	------------------------	------------------------	-------------------

ROLLER DOOR GARAGES



LIFETIME WARRANTY



MAINTENANCE FREE



Double Roller Door RG60602N2 in Woodland Grey®

PRODUCT

SPECIFICATIONS

DIMENSIONS



MODEL: RG37601N2

- » 3.70mW x 6.00mD x 3.20mH
- » Shown in Woodland Grey®
- » Single Garage with single roller door
- » Personal access door available
- » Wind Rating: N2

Colour® \$5,063

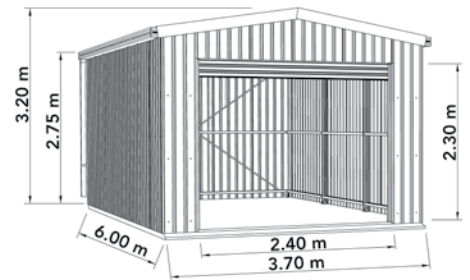

MODEL: RG60602N2

- » 5.95mW x 5.95mD x 3.40mH
- » Shown in Pale Eucalypt®
- » Double Garage with double roller doors
- » Personal access door available
- » Wind Rating: N2

Colour® \$6,043

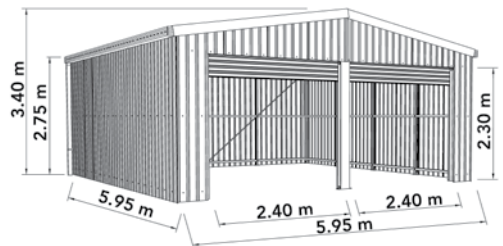

- Assembly videos available on the app
- All galvanised framing sections marked with part numbers

- Maintenance free all steel construction
- For non-cyclonic areas only
- Skylight Sheet available (1.9m x 0.75m)

NOTE: Engineers plans for submission to local authority required. Check with your local council before ordering.

PATIO COVERS

- Maintenance free all steel construction
- Downpipes and gutters included
- SKYAW Skylight Panel Available: 2930mm x 750mm



AWN63 Shown in Classic Cream™

Easily attached to any wall and wide enough to double as a carport. Council plans provided, including guidelines on how to attach to timber/metal fascia & brick work.

PRODUCT

SPECIFICATIONS

DIMENSIONS



MODEL: PATIO3

- » 3.00mW x 3.00mD x 3.00mH
- » Standard Clearance: 2.75m
- » Shown in Classic Cream™
- » Wind Rating C2

Zincalume® \$757

Colour® \$882

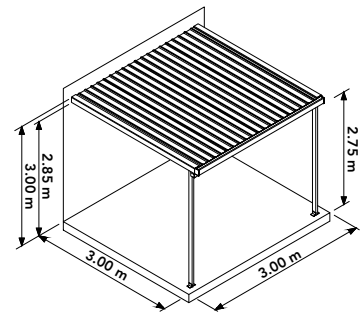

MODEL: PATIO6

- » 6.00mW x 3.00mD x 3.00mH
- » Standard Clearance: 2.75m
- » Shown in Monument®
- » Wind Rating C2

Zincalume® \$1,121

Colour® \$1,247

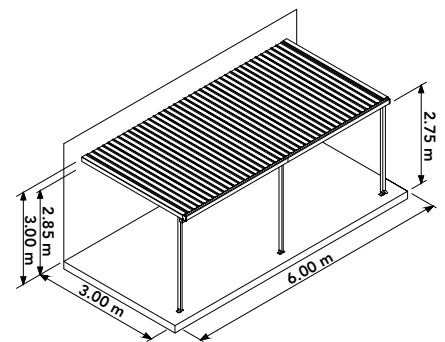

PATIO COVER COLOUR OPTIONS:

Zincalume® (ZA)	Classic Cream™ (CC)	Pale Eucalypt® (PE)	Woodland Grey® (WG)	Monument® (MN)
--------------------	------------------------	------------------------	------------------------	-------------------

* Pale Eucalypt® and Classic Cream™ Patio Covers come with Classic Cream™ frame and posts.

** Zincalume®, Woodland Grey® and Monument® Patio Covers come with Zincalume® frame and posts.

*** Colour not included on both sides. Underside of Patio Cover is Shadow Grey.



Patio Covers are wind rated C2.

SKILLION ROOF CARPORTS



CARPORTS33 Shown in Zinalume®

PRODUCT

SPECIFICATIONS

DIMENSIONS



MODEL: CARPORTS33

- » 3.00mW x 5.50mD x 2.25mH
- » Standard Clearance: 2.06m
- » Wind Rating: N2
- » Shown in Zinalume®

Zinalume® \$971

Colour® \$1,401

Extra High Carport (Adds 600mm) MODEL: CARPORTS33EX6

Zinalume® \$2,290	Colorbond® \$2,666
-------------------	--------------------

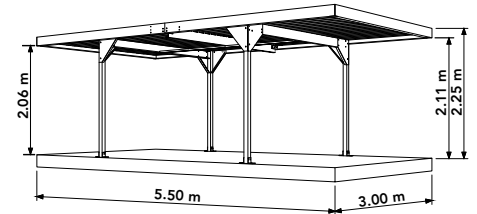

MODEL: CARPORTS50

- » 3.00mW x 5.50mD x 2.25mH
- » Standard Clearance: 2.06m
- » Wind Rating: C2
- » Shown in Woodland Grey®

Zinalume® \$2,343

Colour® \$2,880

Extra High Carport (Adds 600mm) MODEL: CARPORTS50EX6

Zinalume® \$3,774	Colorbond® \$4,469
-------------------	--------------------

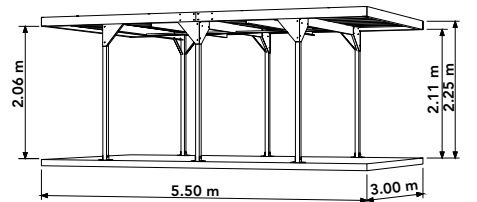

CARPORT COLOUR OPTIONS:

Zinalume® (ZA)	Classic Cream™ (CC)	Pale Eucalypt® (PE)	Woodland Grey® (WG)	Monument® (MN)
-------------------	------------------------	------------------------	------------------------	-------------------

NOTE: Engineers plans for submission to local authority required. Check with your local council before ordering.



LIFETIME WARRANTY



AUSTRALIAN MADE



MAINTENANCE FREE



CARPORTD33 Shown in Woodland Grey®

PRODUCT

SPECIFICATIONS

DIMENSIONS

MODEL: CARPORTD33

- » 5.50mW x 5.50mD x 2.25mH
- » Standard Clearance: 2.06m
- » Wind Rating: N2
- » Shown in Classic Cream™

Zinalume® \$1,766

Colour® \$1,973

Extra High Carport (Adds 600mm)
MODEL: CARPORTD33X6

Zinalume® \$3,166

Colorbond® \$3,373

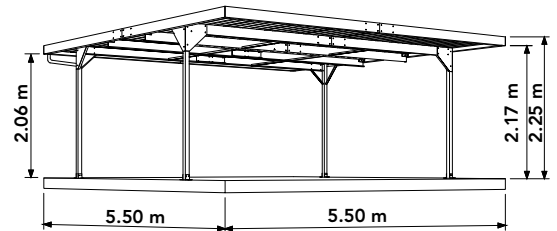

MODEL: CARPORTD50

- » 5.50mW x 5.50mD x 2.25mH
- » Standard Clearance: 2.06m
- » Wind Rating: C2
- » Shown in Pale Eucalypt®

Zinalume® \$4,003

Colour® \$4,671

Extra High Carport (Adds 600mm)
MODEL: CARPORTD50EX6

Zinalume® \$5,358

Colorbond® \$5,966

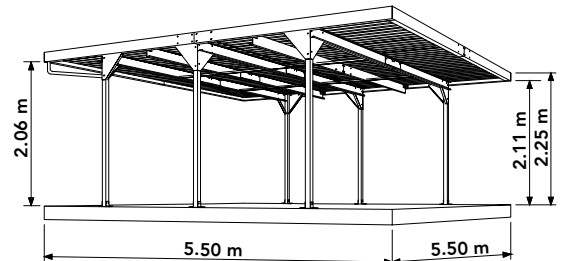

ALL CARPORTS HAVE THE FOLLOWING:

Carports come with Zinalume® posts & framework. Underside of carport is Shadow Grey. Gutters form part of roof frame. Separate downpipes are included.

All fixings, including the concrete slab attachments are standard. Anchors included. A Cyclone kits not available for these models.

GABLE ROOF CARPORTS

GCPDW41 Shown in Woodland Grey®



ALL CARPORTS HAVE THE FOLLOWING:

Carports come with Zinalume® posts & framework. Underside of carport is Shadow Grey.

Gutters form part of roof frame. Separate downpipes are included.

All fixings, including the concrete slab attachments are standard. Anchors included. A Cyclone kit not available for these models.

CARPOT COLOUR OPTIONS:

Zinalume® (ZA)	Classic Cream™ (CC)	Pale Eucalypt® (PE)	Woodland Grey® (WG)
-------------------	------------------------	------------------------	------------------------

NOTE: Engineers plans for submission to local authority required. Check with your local council before ordering.



GCPDW41 Shown in Woodland Grey®

PRODUCT

SPECIFICATIONS

DIMENSIONS

MODEL: GCARPORTS41

- » 3.00mW x 6.00mD x 2.66mH
- » Standard Clearance: 2.17m
- » Wind Rating: N3
- » Shown in Classic Cream™

Zinalume® \$3,495 Colour® \$4,151

Extra High Carport (Adds 600mm) MODEL: GCARPORTS41EX6	
Zinalume® \$4,871	Colorbond® \$5,601

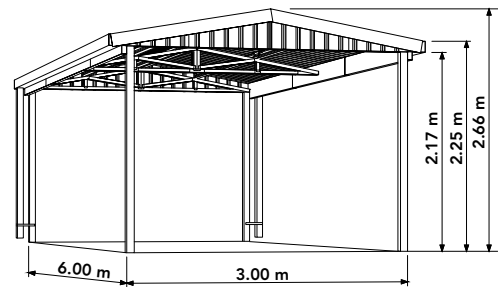

MODEL: GCARPORTD41

- » 6.00mW x 6.00mD x 2.98mH
- » Standard Clearance: 2.17m
- » Wind Rating: N3
- » Shown in Woodland Grey®

Zinalume® \$4,138 Colour® \$4,780

Extra High Carport (Adds 600mm) MODEL: GCARPORTD41EX6	
Zinalume® \$5,442	Colorbond® \$6,722

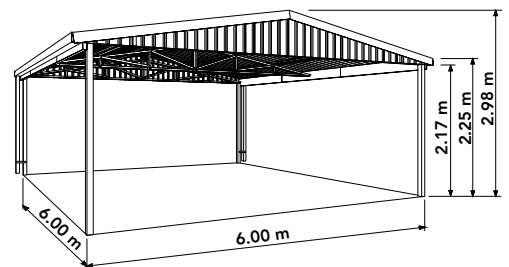

ECONOMY SPACE SAVERS



AUSTRALIAN
MADE



20 YEAR
WARRANTY



HIGH TENSILE
STEEL



SNAPTITE
ASSEMBLY



Absco Economy Sheds are budget - friendly, without sacrifice of durability or quality. From our space savers to workshop sheds, you will always find the perfect storage solution for you!

PRODUCT

SPECIFICATIONS

DIMENSIONS



MODEL: 15081SECOK

- » 1.52mW x 0.78mD x 1.95mH
- » Skillion Roof, Single Door
- » Wind Rating: N2
- » Shown in Grey

Zinc \$239

Colour \$338

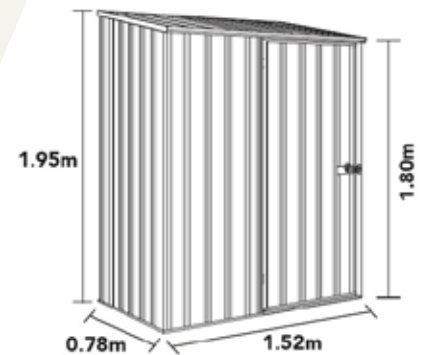

MODEL: 23151SECOK

- » 2.26mW x 1.52mD x 2.08 mH
- » Skillion Roof, Single Door
- » Wind Rating: N2
- » Shown in Cream

Zinc \$496

Colour \$496

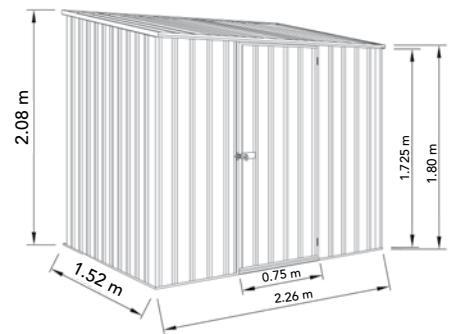

MODEL: J30082SECOK

- » 3.00mW x 0.78mD x 1.95 mH
- » Skillion Roof, Double Door
- » Shown in Grey

Zinc \$567

Colour \$567

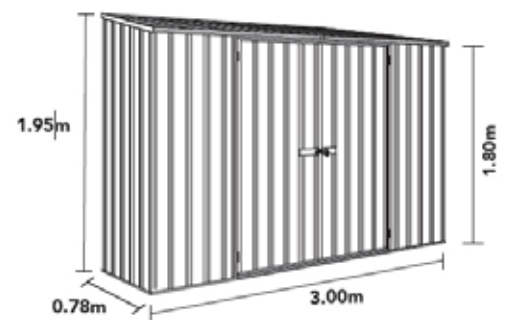

ECONOMY SPACE SAVER COLOUR OPTIONS:



ECONOMY PREMIER SHEDS

20
YEAR

20 YEAR
WARRANTY

PRODUCT

SPECIFICATIONS

DIMENSIONS



MODEL: 30232GECOK

- » 3.00mW x 2.26mD x 2.00mH
- » Gable Roof, Double Door
- » Wind Rating: N2
- » Shown in Grey

Zinc \$566

Colour \$627

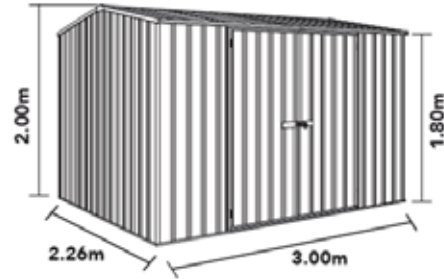

MODEL: 30302GECOK

- » 3.00mW x 3.00mD x 2.06mH
- » Gable Roof, Double Door
- » Wind Rating: N2
- » Shown in Zinc

Zinc \$577

Colour \$685

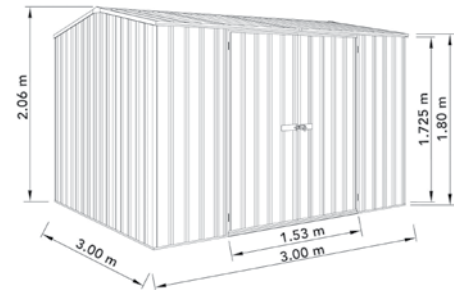

ECONOMY PREMIER COLOUR OPTIONS:

ZINC

CREAM

GREY

ECONOMY WORKSHOP SHEDS



AUSTRALIAN
MADE

PRODUCT

SPECIFICATIONS

DIMENSIONS



MODEL: 52233WECOK

- » 5.22mW x 2.26mD x 2.06mH
- » Gable Roof, Triple Door
- » Wind Rating: N2
- » Shown in Grey

Zinc \$1,315

Colour \$1,847

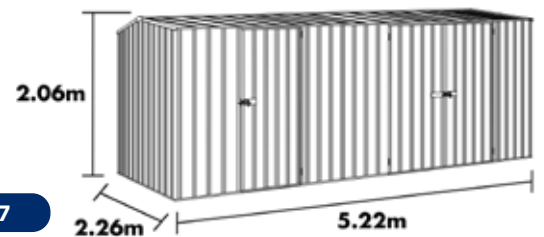

ECONOMY WORKSHOP COLOUR OPTIONS:

ZINC

CREAM

GREY

ACCESSORIES



ANCHOR KITS - \$29

- » 4 Pack includes:
 - » 4 x 10mm Bolts & Nuts
 - » 4 x Strong 3mm Galvanised Brackets
 - » 4 x 10mm Dynabolts
- » Model: ANCHOR4
- » Permanent secure installation
- » Manufacturers 10 Year Warranty
- » Warranty Compliant for Absco Sheds

8 ANCHORS (2 packs)	12 ANCHORS (3 packs)	16 ANCHORS (4 packs)	24 ANCHORS (6 packs)
1.52m x 0.78m	2.26m x 1.52m	3.00m x 1.52m	3.00m x 4.48m
1.52m x 1.52m	2.26m x 2.26m	3.00m x 2.26m	3.00m x 5.22m
2.26m x 0.78m		3.00m x 3.00m	4.48m x 2.26m
3.00m x 0.78m		3.00m x 3.70m	4.48m x 3.00m
			5.22m x 2.26m
			6.00m x 3.00m

SNOW FRAMES - \$249

- » Model: SNOW3018
- » Ensures strength during winter
- » Fits inside 3m wide garden sheds
- » Number of snow frames required depends on size of the shed.
Please refer to our website:
www.absco sheds.com.au



TIMBER FLOORING KIT - \$195

- » 1.52mW x 0.78mD
- » Model: TIMBFLLR
- » 100% Australian renewables plantation grown timber
- » Pre-measured, cut & treated for long term protection
- » Ideal for sloping sites
- » Easy to assemble with full instructions
- » Not suitable in high wind areas
- » Manufacturer's 10 year warranty

Note: Timber floor kits are designed as a temporary flooring solution. Sheds must be anchored to a concrete slab to comply with Absco Sheds Lifetime Warranty.

SHED SIZE	KITS REQ.
1.5m x 0.8m	1
1.5m x 1.5m	2
2.3m x 0.8m	1.5
2.3m x 1.5m	3
2.3m x 2.3m	4.5
3.0m x 2.26m	6
3.0m x 3.0m	8

*Models with sliding doors are not compatible with timber flooring kits

Timber Floor Kit

SKYLIGHT / SLIDING PERSPEX WINDOW

Skylight sheets enable light into your shed without the need for electricity. Made from tough fibreglass, this sheet is to be used when erecting the roof of your shed. Manufacturer's 10 year warranty.

SUITABLE FOR	MODEL	PRICE
Awnings Skylight: 2930mm (L) x 780mm (W)	SKYAW	\$239
Garages Skylight: 1900mm (L) x 750mm (W)	SKYGA	\$236
Rural Shed Skylight: 1580mm (L) x 750mm (W)	SKYRS	\$99
Garden Sheds Skylight: 1545mm (L) x 330mm (W)	SKYSH	\$99
Sliding Perspex Window: 730mm (L) x 230mm (W)	SLPW	\$144

- » Maximum of 1 perspex window per 2.3 meter panel
- » Garden Sheds Skylight: not available on smaller sheds (1545mm deep or less)
- » Skylight made from tough fibreglass
- » Sliding perspex window made from tough acrylic sheeting and PVC frame

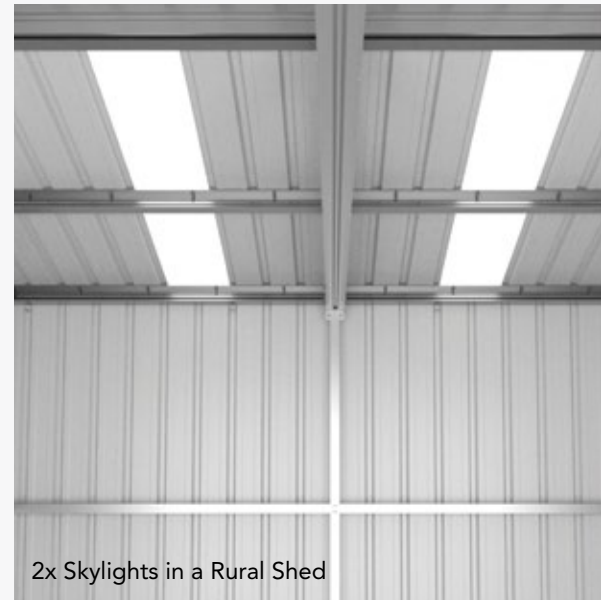

2x Skylights in a Rural Shed

CYCLONE KIT

Cyclone Kits upgrade the wind rating of your shed to C1.

Most Absco Sheds are approved to Australian Standards AS11790.2.02 non-cyclonic conditions (N2)*. Installing a Cyclone Kit will upgrade your shed to C1. Please check the wind rating carefully and check the requirements with your local council before purchasing.

Information

- » Each frame kit is compatible with multiple shed sizes, as our sheds range in size from 1.5m to 6m. Cutting the frame to size is necessary for some models.
- » Installation of the Cyclone Kit is required *during* the garden shed assembly for the Regent, Utility, Workshop and Highlander Cyclone Kits. The Space Saver, Premier and 1.5m Cyclone Kits can be installed after shed construction.

MODEL	CYCLONE KIT	PRICE
1.5mW x 1.5mD Sheds	CYC15	\$320
Space Saver Range	CYCSKRSK	\$400
Premier Range	CYCGK	\$613
Regent Range	CYCRK	\$812
Utility Range	CYCWKUTK	\$1,018
Workshop Range		
Highlander Range	CYCHK	\$1,018



“We have a block of land in Mission Beach with an Absco Shed on it. Our shed has survived both Cyclone Larry and Cyclone Yasi and we couldn't be happier or more relieved to find it still intact thanks to the Absco Cyclone Kit installed.”

PATRICK, MISSION BEACH QLD
CUSTOMER TESTIMONIAL

HOW TO CHOOSE AN ABSCO PRODUCT

STEP 1 - SIZE & COLOUR

Measure the space you have available and what colour would suit your surroundings. Absco products are available in Zinalume® and COLORBOND® colours, with Surfsmist® trim unless otherwise stated.

Recommendation: Lay a concrete slab prior to building your shed. When laying a concrete slab, ensure there is a rebated edge 25mm deep, 75mm wide, around the perimeter. This will help water egress from the base of the shed.

STEP 2 - ROOF & DOORS

Absco sheds come with either a Gable, Skillion or Flat roof. Some ranges come with single, double, hinged, roller or sliding doors. Space Saver sheds have a sloping skillion roof designed specifically for small areas. Both Premier & Regent sheds have a gable roof and use a roof ridge beam. Premier & Regent sheds come with hinged doors. Absco Garages come with shutter, roller or barn doors. Personal access doors are available to purchase for all garages.

STEP 3 - CYCLONE KIT

Most Absco sheds are approved to Australian Standards AS11790.2.02 non-cyclonic conditions (N2). See table above on how to choose the right cyclone kit for your shed if you wish to have a higher wind rating than N2. If you reside in a cyclonic region please note the information in the guidelines prior to making your purchase.

Warning: It is recommended that new Galvanized mesh on your chicken coop should be weathered for two (2) months or scrubbed with a mild acidic solution such as vinegar, then rinsed with water before being used in bird housing appliances.

CYCLONIC REGION GUIDELINES

- 1 SELECT PRODUCT
- 2 ABSCO PLANS
- 3 BUILDING APPROVAL
- 4 PURCHASE
- 5 CONSTRUCTION

Most Absco products are suitable for construction in Queensland non-cyclonic regions (N2) but are not suitable for construction and will not gain council building approval in some cyclonic regions within 100km of the northern coastline of Australia.

The wind classification of your property depends on Wind Region, Terrain Category, Shielding Factor, and Topography Effect. This information is outlined in our Cyclone Kit Upgrade Guidelines & Classifications document.

For more information on wind classifications in your area, please check with your local council before purchasing an Absco product.

Documentation:

For construction in cyclonic regions it is essential that you apply for and attain written council building approval before you purchase. Once you have selected your Absco product, email the model number together with your site address to: admin@absco.com.au and we will email you the corresponding engineering documentation that you will need to submit for your building permit.

Absco will not accept any responsibility or liability, for any Absco product supplied or constructed within a cyclonic region prior to receiving a written building approval that may subsequently fail to receive final building certification.

ABSCO SHEDS MATRIX TABLE

DIMENSIONS
& WIND RATINGS

CODE	SHED SIZE				CLEARANCES		WIND RATING	CYCLONE KIT UPGRADE
	WIDTH (mW)	DEPTH (mD)	WALL HEIGHT (mH)	HIGHEST POINT (mH)	DOOR			
					WIDTH (mm)	HEIGHT (mm)	N2	C1
SPACE SAVER								
15081SK	1.52	0.78	1.80	1.95	750	1725	X	
15151SK	1.52	1.52	1.80	2.08	750	1725	X	CYC15
23081SK	2.26	0.78	1.80	1.95	750	1725		
23151SK	2.26	1.52	1.80	2.08	750	1725	X	CYCSKRSK
30082SK	3.00	0.78	1.80	1.95	1530	1725		
30151SK	3.00	1.52	1.80	2.08	750	1725	X	CYCSKRSK
30152SK	3.00	1.52	1.80	2.08	1530	1725	X	CYCSKRSK
REVERSE SKILLION SPACE SAVER								
15081RSK	1.52	0.78	1.65	1.80	750	1725	X	
23151RSK	2.26	1.52	1.52	1.80	750	1725	X	CYCSKRSK
PREMIER								
15151GK	1.52	1.52	1.80	1.95	750	1725	X	CYC15
23151GK	2.26	1.52	1.80	1.95	750	1725	X	CYCGK
23231GK	2.26	2.26	1.80	2.00	750	1725	X	CYCGK
30152GK	3.00	1.52	1.80	1.95	1530	1725	X	CYCGK
30232GK	3.00	2.26	1.80	2.00	1530	1725	X	CYCGK
30302GK	3.00	3.00	1.80	2.06	1530	1725	X	CYCGK
REGENT								
23141RK	2.26	1.44	1.80	2.00	750	1725	X	CYCRK
23221RK	2.26	2.18	1.80	2.00	750	1725	X	CYCRK
30142RK	3.00	1.44	1.80	2.06	1530	1725	X	CYCRK
30222RK	3.00	2.18	1.80	2.06	1530	1725	X	CYCRK
30292RK	3.00	2.92	1.80	2.06	1530	1725	X	CYCRK
30372RK	3.00	3.66	1.80	2.06	1530	1725	X	CYCRK
BASIC SHEDS								
15231FK	1.52	2.26	1.80	1.80	750	1725	X	
15301FK	1.52	3.00	1.80	1.80	750	1725	X	
BIKE SHED								
230813BK	2.26	0.78	1.31	1.31	1560	1120		
J30153BK	3.00	1.52	1.80	2.08	1530	1725	X	
POOL PUMP COVER								
PPCK	1.52	1.52	1.22	1.49	770	1140		
EZI STORAGE RANGE								
08081FK	0.78	0.78	1.80	1.80	690	1725		
08151FK	0.78	1.52	1.80	1.80	690	1725		
30082EK	3.00	0.78	1.80	1.95	1440	1725	X	
HIGHLANDER								
30292HK	3.00	2.92	2.05	2.30	1530	1970	X	CYCHK
3045HK	3.00	4.48	2.05	2.30	2290	1970	X	CYCHK
3060HK	3.00	5.96	2.05	2.30	2290	1970	X	CYCHK
45232HK	4.48	2.26	2.05	2.30	1530	1970	X	CYCHK
60303HK	5.96	3.00	2.05	2.30	1530	1970	X	CYCHK
UTILITY								
3045UTK	3.00	4.48	1.80	2.06	2290	1725	X	CYCWKUTK
3060UTK	3.00	5.96	1.80	2.06	2290	1725	X	CYCWKUTK
WORKSHOP								
45232WK	4.48	2.26	1.80	2.00	1530	1725	X	CYCWKUTK
45302WK	4.48	3.00	1.80	2.06	1530	1725	X	CYCWKUTK
60303WK	5.96	3.00	1.80	2.06	1530	1725	X	CYCWKUTK

CODE	SHED SIZE				CLEARANCES		WIND RATING		
	WIDTH (mW)	DEPTH (mD)	WALL HEIGHT (mH)	HIGHEST POINT (mH)	DOOR		N2	N3	C2
					WIDTH (mm)	HEIGHT (mm)			
FORTRESS SHED									
30081LK	3.00	0.78	2.4	2.4	2300	1950			
30151LK	3.00	1.52	2.4	2.4	2300	1950			
30301LK	3.00	3.00	2.4	2.4	2300	1950			
RURAL SHED									
3030RS	3.00	3.00	2.05	2.53	2800	1930	X		
GARAGES - BARN DOOR									
CG34552N2	3.42	5.50	2.17	2.47	2470	2180	X		
CG56552N2	5.64	5.50	2.15	2.64	4400	2210	X		
GARAGES - ROLLER DOOR									
RG37601N2	3.70	6.00	2.75	3.20	2400	2300	X		
RD60602N2	5.95	5.95	2.75	3.40	2400	2300	X		
BUSHRANGER SHEDS									
3023BRK	3.00	2.26	2.05	2.30	2300	1824			
3030BRK	3.00	3.00	2.05	2.30	2300	1824			
3060HGK	3.00	5.96	2.05	2.30	2290	1970			
PATIO COVERS									
PATIO3	3.00	3.00	3.00						X
PATIO6	6.00	3.00	3.00						X
CARPORTS - SKILLION									
CARPORTS33	3.00	5.50	2.06	2.25			X		
CARPORTS50	3.00	5.50	2.06	2.25					X
CARPORTD33	5.50	5.50	2.06	2.25			X		
CARPORTD50	5.50	5.50	2.06	2.25					X
CARPORTS33EX6	3.00	5.50	2.06	2.85			X		
CARPORTS50EX6	3.00	5.50	2.06	2.85					X
CARPORTD33EX6	5.50	5.50	2.06	2.85			X		
CARPORTD50EX6	5.50	5.50	2.06	2.85					X
CARPORTS - GABLE									
GCARPORTS41	3.00	6.00	2.17	2.66				X	
GCARPORTD41	6.00	6.00	2.17	2.98				X	
GCARPORTD41EX6	3.00	6.00	2.17	3.26				X	
GCARPORTD41EX6	6.00	6.00	2.17	3.58				X	
CHICKEN COOPS									
A15081FKFD	1.52	0.78	1.80	1.80	700	1725			
A15151FKFD	1.52	1.52	1.80	1.80	700	1725			
A15301FKFD	1.52	2.96	1.80	1.80	700	1725			
A23151GKFD	2.26	1.52	1.80	2.00	700	1725			
A23231GKFD	2.26	2.22	1.80	2.00	700	1725			
A30231GKFD	3.00	2.22	1.80	2.06	700	1725			

ECONOMY RANGE

CODE	SHED SIZE				CLEARANCES		WIND RATING		
	WIDTH (mW)	DEPTH (mD)	WALL HEIGHT (mH)	HIGHEST POINT (mH)	DOOR		N2	N3	C2
					WIDTH (mm)	HEIGHT (mm)			
SPACE SAVER									
15081SECOK	1.52	0.78	1.80	1.95	750	1725	X		
23151SECOK	2.26	1.52	1.80	2.08	750	1725	X		
J30082SECOK	3.00	0.78	1.80	1.95	1530	1725			
PREMIER SHEDS									
30232GECOK	3.00	2.26	1.80	2.00	1530	1725	X		
30302GECOK	3.00	3.00	1.80	2.06	1530	1725	X		
WORKSHOP SHEDS									
52233WECOK	5.22	2.26	1.80	2.06	1530	1725	X		

Absco Sheds have undertaken every effort to ensure all images, pricing and product information is correct and relevant at the time of printing. We reserve the right to correct printing errors at any time without notice. Images included in this catalogue are for illustrative purposes only and may not show all or correct colours, product features and/or optional extras. Absco Sheds - June 2021



CONTACT US 7 DAYS A WEEK



6-12 Activity St, Acacia Ridge QLD 4110
PO Box 119, Acacia Ridge QLD 4110



AU 1800 029 701
NZ 0800 466 444



admin@absco.com.au
www.abscosheds.com.au